

Katalog Stolar



Office Chairs

Gäller från 130901



Innehåll

WINDY Arbetstol se sida 8-9
TOUCH Arbetstol se sida 10
SKIN-KELLY Multistol se sida 11-12
NICLA Multistol se sida 13
ZANTE stol och barstol se sida 14
BEETLE stol och barstol se sida 15
BRAVA-LOOK-GHOST stol se sida 16
LED Barstol se sida 17

FLAMENCA stol och flersits från sidan 18
MELODE flersits se sida 20
DAISY Sittpuffar se sida 20
LYRA-BARRY-VIP fåtölj se sida 21
MUSA-STAGE fåtölj se sida 21
QUICK byggbar soffa från sida 22
Övrigt se sida 25
Klädsel/Tyger från sida 26

Allmän information

Tyger / Klädsel (från sidan 26)

Alla tyger är testade enligt EN normer.

Prisklass 10:

Prisklass 30:

Prisklass 50:

Prisklass 70:

Kundtyg: Offereras

Stolar

Våra stolar finns som arbetstolar, möte, konferens, fåtöljer eller soffor i olika utföranden och design.

Provning

Stolarna är testade och godkända enligt EN normer och krav. Testprotokoll finns att beställa.

Garanti

Fem års garanti på samtliga varor, räknat från leveransmånad och avser felaktighet i funktion, material eller tillverkning under förutsättning att produkten vårdats och brukats normalt (8 tim/dag). Vid längre användning än normalt (t.ex. 24 tim/dygn) gäller ett års garanti. Kan ett fel avhjälpas genom att en lätt utbytbar del av produkten ersätts, fullgör säljaren garantiansvaret genom att, efter eget avgörande sända köparen en utbytesdel tillsammans med en monteringsanvisning. Utbytet sker i köparens försorg.

Miljö

Vi har infört ett miljöledningssystem motsvarande kraven enligt SS-EN ISO 14001.

Vi är anslutna till REPA-registret.

Kvalitet

Vi har infört ett kvalitetssäkringssystem motsvarande ISO 9001.

Priser

Alla våra priser är exklusive mervärdesskatt. Offert är bindande i 30 dagar om ej annat avtalats. Alla priser är rekommenderade priser, lokala variationer kan förekomma.

Betalningsvillkor

30 dagar netto. Dröjsmålsränta debiteras med 15 %. Utrustningen övergår ej i köparens ägo förrän full betalning erlagts.

Leveransvillkor

Fritt fabrik.

Leveranstid

Varorna levereras från fabrik under angiven dag.

Snabblager 5 days produkter märkta i prislista.

3-4 veckor på standardsortiment.

3-6 veckor på stora projekt och special tillverkning.

Kontrollera alltid med oss för exakt leveranstid.

Transportskada

Transportskador reklameras direkt till speditör vid lossning. Eventuella reklamationer skall meddelas Holmbergsbordet inom 5 dagar från det att godset mottagits. Retur av gods godkännes först efter överenskommelse. Returnerat gods skall förses med angivet ordernummer och i de fall Holmbergsbordet skall stå för returfrakten anlitas DHL, kundnr. 870659.

Emballage

Emballage tillkommer på leverans av lösdel.

Övrig information

Holmbergsbordet förbehåller sig rätten till smärre förändringar i konstruktions- och modellutförande samt därav uppkomna prisjusteringar.

Befrielsegrunder (force majeure)

Säljaren och köparen äger ej gentemot varandra åberopa underlåtenhet att fullgöra avtalet, om dess fullgörande väsentligen försvåras till följd av arbetskonflikt eller omständigheter utanför partens kontroll såsom krig, mobilisering, politiska oroligheter, statsingripanden av olika slag, eldsvåda, naturhändelse, kraftbrist, trafikrubbingar eller omfattande driftstörningar hos parten samt bristande prestationer från underleverantörer på grund av omständighet som avses i denna punkt. Har part ej utan dröjsmål skriftligen underrättat andra parten om att sådan omständighet inträffat, äger han ej åberopa denna såsom befrielsegrund. Medför omständighet som avses i denna punkt att avtalet ej kan fullgöras inom skälig tid, äger vardera parten skriftligen häva avtalet till den del dess fullgörande uteblivit. Därest köparen i dylika fall häver avtalet, äger säljaren erhålla ersättning för de kostnader som han intill tidpunkten för avtalets hävande nedlagt för leveransens fullgörande; dock ej för det som han kan tillgodogöra sig i sin rörelse.

För mer information ring 0612 224 35

eller vår hemsida. www.holmbergsbordet.se



Ny arbetsplats!



Ny mötesplats!





SKIN



TOUCH



KELLY



WINDY ZEB+



WINDY ZEB



WINDY ZEN



WINDY ZEUS



WINDY STRATA³

WINDY

Series / Serien

Raised base in reinforced Black nylon, with soft castors diam. 65 mm
 Height adjustable backrest 60 mm, 62,5 mm sliding seat
 Lumbar support with pump, Seat front inclination mechanism
 Tension soft mechanism, sit height 420-580 mm.

European Norms UNI EN 1335
 tipe "A" and "B" D.L.81

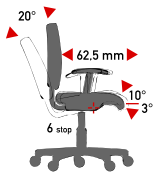

Högt kryss i extra förstärkt Svart nylon, mjuka hjul 65 mm
 Höjdjusterbar Rygg 60 mm, 62,5 mm skjutbar sits
 Svankstöds justering med pump, Sitsvinkel reglering
 Synkroningunga vinklångsbar 20 gr. Med ställbart motstånd
 och låsbar i 6 olika positioner. Sitthöjd 420-580 mm

Fabric / Klädsel

10	30	50	70

Description / Benämning		Cod / Artikelnr			
	Windy ZEB Medium Rygg	WY ZB			
	Medium backrest 58 cm. Medium hög rygg 58 cm.				
	Medium backrest 58 cm with extra padding (De Luxe) Medium hög rygg 58 cm med extra stoppning (De Luxe)	WY ZBDL			
	Windy ZEB+ Hög Rygg med integrerat Nackstöd	WY ZB+			
	High backrest 76 cm with headrest Hög rygg 76 cm med nackstöd				
	High backrest 76 cm with headrest, extra padded (De luxe) Hög rygg 76 cm med nackstöd, extra stoppning (De Luxe)	WY ZB+DL			
	Windy ZEUS Hög snygg formad Rygg med extra komfort	WY ZS			
	High comfort backrest Hög rygg med extra komfort				
	High comfort backrest with extra padded seat (De luxe) Hög rygg med extra komfort och extra stoppad sits (de Luxe)	WY ZSDL			
	Add Ons / Tillval				
	Pair of 2D height adjustable armrests in reinforced nylon 2D Armstödspar i förstärkt nylon justerbart i höjdd/bredd	0880N+TT810			
	Width adjustment / Breddjustering Included / Ingår	TT810			
	Pair of polished aluminium armrests with 4D multifunction Armstödspar i polerad aluminium med 4D multifunktion	0850C+TT810			
	Headrest for ZEB and ZEUS, adjustable Nackstöd för ZEB och ZEUS, justerbart i höjd/djup	TT 300			
	Large Seat for Windy series Stor sits för Windy serien	WY SEAT L			
	Extra padded Large Seat for Windy series Extra stoppad stor sits för Windy serien	WY SEAT L-DL			
	For version with polished aluminium base, amount to add Tillägg för kryss i polerad aluminium	0905 C			
	For version with grey laquered base, amount to add Tillägg grålackat kryss	0905 V			
	Addon for Sit height 460-620 mm(replaces Std.height). Tillägg för ökad Sitthöjd 460-620mm (ersätter Std.höjd).	T-4662			
	For other gaslifts please contact us. För andra typer av gaspelare, kontakta oss.	Endast vid nybeställning av stol			
	Hard Castor Ø 65 mm, self-braking. Per piece Hårt Hjul Ø 65 mm, självbromsande. Per styck	0311			
		Inget tillägg vid nybeställning av stol			

WINDY

Series / Serien



Raised base in reinforced Black nylon, with soft castors diam. 65 mm
Height adjustable backrest 60 mm, 62,5 mm sliding seat
Seat front inclination mechanism (A)
Tension soft mechanism, sitheight 420-580 mm

Högt kryss i extra förstärkt Svart nylon, mjuka hjul 65 mm
Höjdjusterbar Rygg 60 mm, 62,5 mm skjutbar sits
Sitsvinkel reglering
Synkronunga vinklingsbar 20 gr. Med ställbart motstånd
och låsbar i 6 olika positioner. Sitthöjd 420-580 mm

European Norms UNI EN 1335
tipe "A" and "B" D.L.81

Fabric / Klädsel

10	30	50	70

Description / Benämning

Cod / Artikelnr

Windy STRATA med svart nät rygg
Medium rygg

WYST

Medium backrest in black net
Medium rygg i svart nät

Medium backrest in net with extra padded seat (De Luxe)
Medium rygg i nät med extra stoppad sits (De Luxe)

WYSTDL

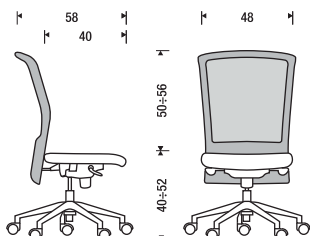

Windy ZEN med rygg i svart nät
Medium Rygg

WYZN

Medium backrest in black net
Medium rygg i svart nät

Medium backrest in net with extra padded seat (De Luxe)
Medium rygg i nät med extra stoppad sits (De Luxe)

WYZNDL

Lumbar support for Windy ZEN
Svankstöd för Windy ZEN

ZN600

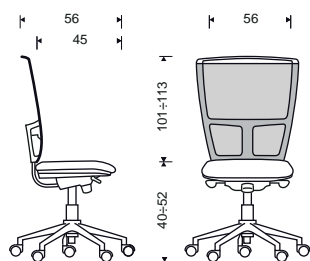

Add Ons / Tillval

Tension Multi mekanism med separat ryggvinkling
8 grader individuellt, samt alla Std.inställningar
och anpassat fäste. (OBS! passar ej för ZEN)

Tension Multi mechanism Windy series
Mekanism Tension Multi för Windy serien

T-MULTI

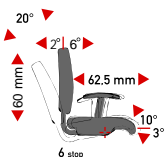

Pair of 2D height adjustable armrests in reinforced nylon
2D Armstödspar i förstärkt nylon justerbart i höjddled/bredd

0880N+TT810

Width adjustment / Breddjustering
Included / Ingår

TT810

Pair of polished aluminium armrests with 4D multifunction
Armstödspar i polerad aluminium med 4D multifunktion

0850C+TT810

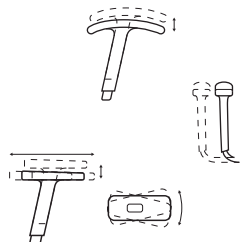

Headrest for Windy ZEN, adjustable
Nackstöd för Windy Zen, justerbart i höjd/djup

ZN 300



Large Seat for Windy series
Stor sits för Windy serien

WY SEAT L

Extra padded Large Seat for Windy series
Extra stoppad stor sits för Windy serien

WY SEAT L-DL

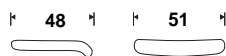

For version with polished aluminium base, amount to add
Tillägg för kryss i polerad aluminium

0905 C

For version with grey laquered base, amount to add
Tillägg grålackat kryss

0905 V



Addon for Sit height 460-620 mm(replaces Std.height).
Tillägg för ökad Sitthöjd 460-620mm (ersätter Std.höjd).

T-4662

Endast vid nybeställning av stol

For other gaslifts please contact us.
För andra typer av gaspelare, kontakta oss.

Inget tillägg vid nybeställning av stol



Hard Castor Ø 65 mm, self-braking. Per piece
Hårt Hjul Ø 65 mm, självbromsande. Per styck

0311

Inget tillägg vid nybeställning av stol



TOUCH

Raised base in reinforced Black nylon, with soft castors diam. 65 mm
 Height adjustable backrest, 100 mm sliding seat
 Depth adjustable lumbar support mechanism
 Seat front inclination mechanism

Högt kryss i extra förstärkt Svart nylon, mjuka hjul 65 mm
 Höjddjusterbar Rygg, 100 mm skjutbar sits
 Svankestöds support i djupled, sitsvinkel reglering
 Synkroningunga vinklingsbar 30 gr. Med ställbart motstånd
 och låsbar i 3 positioner.



Fabric / Klädsel

10	30	50	70

Description / Benämning		Cod / Artikelnr			
<p>Without adjustable headrest Utan Nackstöd</p> <p>Active Synchron "TT", without armrests Aktiv Synchron "TT", utan armstöd</p>		TT115S			
<p>Without adjustable headrest Utan Nackstöd</p> <p>Active Synchron "TT", with 2D adjustable armrests Aktiv Synchron "TT", justerbara 2D armstöd</p> <p>Active Synchron "TT", with 4D adjustable armrests Aktiv Synchron "TT", justerbara 4D armstöd</p>		TT1152D TT1154D			
<p>With adjustable headrest Med justerbart Nackstöd</p> <p>Active Synchron "TT", without armrests Aktiv Synchron "TT", utan armstöd</p>		TT125S			
<p>With adjustable headrest Med justerbart Nackstöd</p> <p>Active Synchron "TT", with 2D adjustable armrests Aktiv Synchron "TT", justerbara 2D armstöd</p> <p>Active Synchron "TT", with 4D adjustable armrests Aktiv Synchron "TT", justerbara 4D armstöd</p>		TT1252D TT1254D			
<p>Width adjustment of armrests 2D and 4D Breddjustering av armstöd 2D och 4D Included in armrests / Ingår i armstöd</p>		TT800			
<p>For version with polished aluminium base, amount to add Tillägg för kryss i polerad aluminium</p>		0905 C			
<p>Hard Castor Ø 65 mm, self-braking. Per piece Hårt Hjul Ø 65 mm, självbromsande. Per styck</p>		0311			

SKIN

Raised base in polished aluminium, with soft castors 65 mm
Seat and backrest in synthetic net, or padded version

Högt kryss i polerad aluminium, mjuka hjul 65 mm
Sits och rygg i syntetiskt nät, eller i stoppad version

Gas lift tilter vinklinsbar 16 gr. med 2 fasta lägen.
Gas lift med självjusterande vinkling vid rörelse ca. 5gr.
Gas lift multiblock vinklinsbar 16 gr. med 4 fasta lägen.

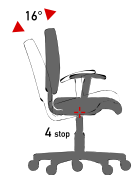

Fabric / Klädsel

	10-30-50	70
Synthetic net Syntetiskt nät	Padded version Stoppad version	

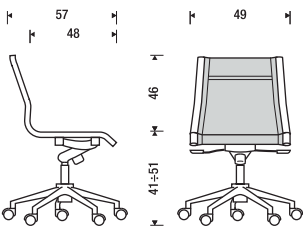
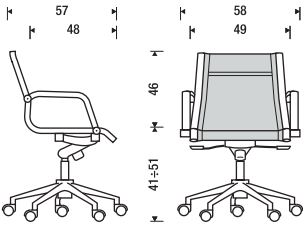
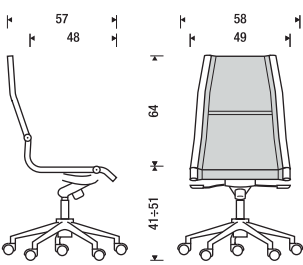
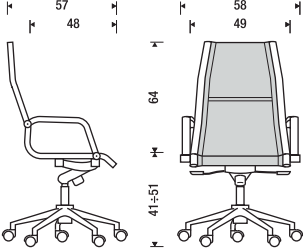
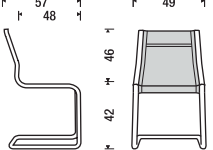
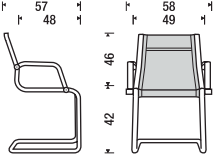
Description / Benämning	Cod / Artikelnr	Fabric / Klädsel	
 <p>Low backrest without armrests Låg rygg utan armstöd</p>		OBS! Lägg till ett T i artikelnumret för Padded/Stoppad version samt färgkod.	
Gas lift, tilter Gaslyft, vinklinsbar rygg	SK503CS		
Gas lift, with harmonic tilter Gaslyft, självjusterande vinkling ca. 5 gr.	SK504CS		
Gas lift, knee-tilter multiblock Gaslyft med multiblock vinklinsmekanism	SK505CS		
 <p>Low backrest, with armrests in polished aluminium Låg rygg med armstöd i polerad aluminium</p>			
Gas lift, tilter Gaslyft, vinklinsbar rygg	SK503C		
Gas lift, with harmonic tilter Gaslyft, självjusterande vinkling ca. 5 gr.	SK504C		
Gas lift, knee-tilter multiblock Gaslyft med multiblock vinklinsmekanism	SK505C		
 <p>High backrest without armrests Hög rygg utan armstöd</p>			
Gas lift, tilter Gaslyft, vinklinsbar rygg	SK513CS		
Gas lift, with harmonic tilter Gaslyft, självjusterande vinkling ca. 5 gr.	SK514CS		
Gas lift, knee-tilter multiblock Gaslyft med multiblock vinklinsmekanism	SK515CS		
 <p>High backrest with armrests in polished aluminium Hög Rygg med armstöd i polerad aluminium</p>			
Gas lift, tilter Gaslyft, vinklinsbar rygg	SK513C		
Gas lift, with harmonic tilter Gaslyft, självjusterande vinkling ca. 5 gr.	SK514C		
Gas lift, knee-tilter multiblock Gaslyft med multiblock vinklinsmekanism	SK515C		
 <p>Low backrest, on skid frame in chrome Låg rygg med gungram i krom</p>			
Chromed skid frame, without armrests Gungram i krom med utan armstöd	SK06CS		
 <p>Low backrest with armrests, on skid frame in chrome Låg rygg med armstöd, gungram i krom</p>			
Chromed skid frame, with armrests Gungram i krom med armstöd	SK06C		
Note! / OBS! Glöm ej	White / Vit	R08	
Specify colour on the order Ange färgkod vid beställning	Black / Svart	R04	
	Light grey / Ljusgrå (Beställningsvara längre Lev.tid) Dark Grey / Mörk Grå (Beställningsvara längre Lev.tid)	R98 / R99	Offereras
	Addon: Armrest with fabric / Tillägg: Klätt armstöd (par)	T-ARF	
	Glides / Glidfötter pris per styck.	0351	Inget tillägg vid nybeställning av stol



KELLY

Raised base in polished aluminium, with soft castors 65 mm
Seat and backrest in self-supporting rete net fabric



COLORI RETE NEST

Högt kryss i polerad aluminium, mjuka hjul 65 mm
Sits och rygg i rete nättig

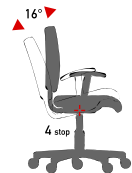
Gas lift tilter vinklignsbar 16 gr. med 2 fasta lägen.
Gas lift med självjusterande vinkling vid rörelse ca. 5gr.
Gas lift multiblock vinklignsbar 16 gr. med 4 fasta lägen.

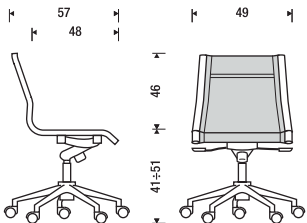
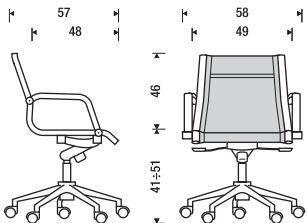
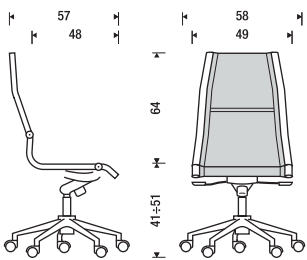
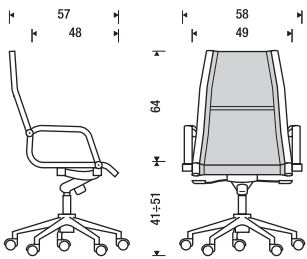
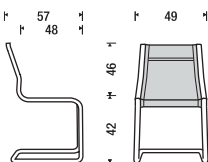
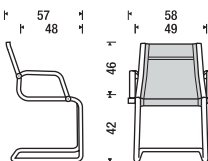

Fabric / Klädsel

		Description / Benämning		Cod / Artikelnr		Rete net Rete nät	
		Low backrest without armrests Låg rygg utan armstöd					
		Gas lift, tilter Gaslyft, vinklignsbar rygg		KL503CS			
		Gas lift, with harmonic tilter Gaslyft, självjusterande vinkling ca. 5 gr.		KL504CS			
		Gas lift, knee-tilter multiblock Gaslyft med multiblock vinklignsmekanism		KL505CS			
		Low backrest, with armrests in polished aluminium Låg rygg med armstöd i polerad aluminium					
		Gas lift, tilter Gaslyft, vinklignsbar rygg		KL503C			
		Gas lift, with harmonic tilter Gaslyft, självjusterande vinkling ca. 5 gr.		KL504C			
		Gas lift, knee-tilter multiblock Gaslyft med multiblock vinklignsmekanism		KL505C			
		High backrest without armrests Hög rygg utan armstöd					
		Gas lift, tilter Gaslyft, vinklignsbar rygg		KL513CS			
		Gas lift, with harmonic tilter Gaslyft, självjusterande vinkling ca. 5 gr.		KL514CS			
		Gas lift, knee-tilter multiblock Gaslyft med multiblock vinklignsmekanism		KL515CS			
		High backrest with armrests in polished aluminium Hög Rygg med armstöd i polerad aluminium					
		Gas lift, tilter Gaslyft,		KL513C			
		Gas lift, with harmonic tilter Gaslyft, självjusterande vinkling ca. 5 gr.		KL514C			
		Gas lift, knee-tilter multiblock Gaslyft med multiblock vinklignsmekanism		KL515C			
		Low backrest, on skid frame in chrome Låg rygg med gungram i krom					
		Chromed skid frame, without armrests Gungram i krom med utan armstöd		KL06CS			
		Low backrest with armrests, on skid frame in chrome Låg rygg med armstöd, gungram i krom					
		Chromed skid frame, with armrests Gungram i krom med armstöd		KL06C			
Note! / OBS! Glöm ej Specify colour on the order Ange färgkod vid beställning		Orange / Orange		R05			
		Grey / Grå		R07			
		Green / Grön		R09			
		Blue / Blå		R06			
		Red / Röd		R01			
		Glides / Glidfötter pris per styck.		0351		Inget tillägg vid nybeställning av stol	

NICLA

Multifunctional chair Multifunktions stol

Order different colour on the movable seat
Kan beställas med separat färg på löstagbar sits

Fabric / Klädsel			
10	30	50	70
-----		-----	
Description / Benämning		Cod / Artikelnr	
 Polished raised aluminium base with castors or glides Högt kryss i polerad aluminium med hjul eller glidfötter			
Gas Lift, castors Gaslyft, hjul		NC101C	
Gas Lift, glides Gaslyft, glidfötter		NC101C-0351	
Gas Lift with harmonic tilter, castors Gaslyft med självjusterande vinkling ca. 5 gr. med hjul		NC104C	
Gas Lift with harmonic tilter and glides Gaslyft med självjusterande vinkling ca. 5 gr. med glidfötter		NC104C-0351	
 Flat chromed steel base with self-centering system Platt fot i krom med automatisk retur			
Non height adjustable Utan höjjustering		NC301C	
 Chromed conical shaped base, swivel Coniskt underrede med snurr i krom			
Gas Lift Gaslyft		NC401C	
Gas Lift with harmonic tilter Gaslyft med självjusterande vinkling ca. 5 gr.		NC404C	
 Chromed Spiderframe (4-leg base) Spider ben (4 delad) i krom			
Fixed, with adjustable glides Fast med justerbara glidfötter		NC501C	
Swivel, with adjustable glides Snurr med justerbara glidfötter		NC511C	
Self centering, with adjustable glides Snurr med retur, justerbara glidfötter		NC521C	
 Extra movable seat Extra löstagbar sittplatta		NCSEAT	



Grey 4 leg frame
Grått underrede med 4 ben

Visitor chair / Besök stol

Description / Benämning

Cod / Artikelnr

Technopolymer shell
Stol i Teknopolymer

WHITE-VIT



ZT108VS-WHT

CREAM-BEIGE



ZT108VS-CRM

LIGHTBLUE-LJUSBLÅ



ZT108VS-LBL

APPLE GREEN-ÄPPEL GRÖN



ZT108VS-GRE

ORANGE-ORANGE



ZT108VS-ORA

RED-RÖD



ZT108VS-RED

DARKGREY-MÖRKGRÅ



ZT108VS-GRY

DARKBROWN-MÖRKBRUN



ZT108VS-DBR

FUCHSIA-CERISE



ZT108VS-FCS

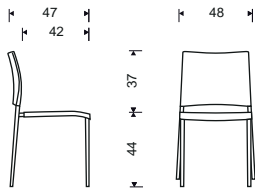

Technopolymer shell
Barstol i teknopolymer

WHITE-VIT



ZT147VS-WHT

CREAM-BEIGE



ZT147VS-CRM

LIGHTBLUE-LJUSBLÅ



ZT147VS-LBL

APPLE GREEN-ÄPPEL GRÖN



ZT147VS-GRE

ORANGE-ORANGE



ZT147VS-ORA

RED-RÖD



ZT147VS-RED

DARKGREY-MÖRKGRÅ



ZT147VS-GRY

DARKBROWN-MÖRKBRUN



ZT147VS-DBR

FUCHSIA-CERISE



ZT147VS-FCS

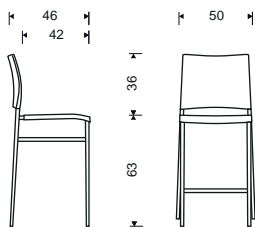

BEETLE

Stackable chair and high chair Barstol och Stapelbara Stolar

Visitor chair / Besök stol

Chromed frame
Kromat underrede

Description / Benämning

Cod / Artikelnr

Technopolymer shell
Stol i Teknopolymer

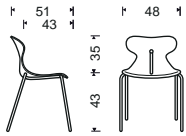

WHITE-VIT



BE108CS-WHT

FUCHSIA-CERISE



BE108CS-FCS

RED-RÖD



BE108CS-RED

BLUE-BLÅ



BE108CS-BLU

Technopolymer shell
Stol med armstöd i teknopolymer

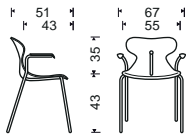

WHITE-VIT



BE108C-WHT

FUCHSIA-CERISE



BE108C-FCS

RED-RÖD



BE108C-RED

BLUE-BLÅ



BE108C-BLU

Technopolymer shell
Barstol i teknopolymer

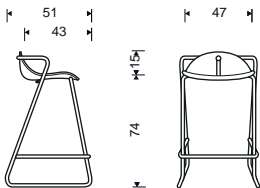

WHITE-VIT



BE147CS-WHT

FUCHSIA-CERISE



BE147CS-FCS

RED-RÖD



BE147CS-RED

BLUE-BLÅ



BE147CS-BLU



BRAVA

EN 1728 : 2000

Stackable chairs Stapelbara Stolar

Chromed 4-leg frame
Kromat underrede med 4 ben

Visitor chair / Besök stol

Description / Benämning

Cod / Artikelnr

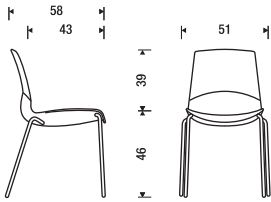

Shell in polypropylene in 2-colour combination
Sits och rygg i 2 färgad polypropen

WHITE-RED / VIT-RÖD



BV108C-RED

WHITE-BLACK / VIT-SVART



BV108C-BLK

WHITE-GREEN / VIT-GRÖN



BV108C-GRN

WHITE-BLUE / VIT-BLÅ



BV108C-BLU

WHITE-SAND / VIT-SAND



BV108C-SND

LOOK

EN 1728 : 2000

Shell with armrests in SAN material
Stol med armstöd i SAN Material

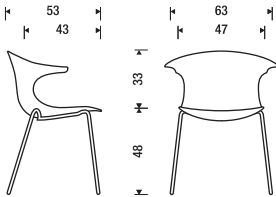

RED-RÖD



LK108C-RED

BLACK-SVART



LK108C-BLK

WHITE-VIT



LK108C-WHT

GREEN-GRÖN



LK108C-GRN

LIGHT BLUE-LJUS BLÅ



LK108C-LBL

GENOMLYSANDE RÖKFÄRG



LK108C-TRF

GENOMLYSANDE GUL



LK108C-TRY

GENOMLYSANDE LILA



LK108C-TRV

GHOST

EN 1728 : 2000
EN 15373 : 2007

Shell in polycarbonate
Stol i polykarbonat

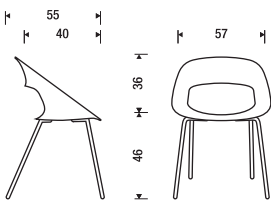

WHITE-VIT



GH108C-WHT

YELLOW-GUL



GH108C-YEL

BLUE-BLÅ



GH108C-BLU

TRANSPARENT



GH108C-TRN

GENOMLYSANDE ORANGE



GH108C-TRO



BRAVA



LOOK



GHOST

OBS! Tänk på att färgavikelser kan förekomma

GHOST

EN 1728 : 2000
EN 15373 : 2007

Stackable chairs Stapelbara Stolar

Chromed skidframe
Stativ på medar i krom

Visitor chair / Besök stol

Description / Benämning

Cod / Artikelnr

Shell in polycarbonate
Stol i polykarbonat

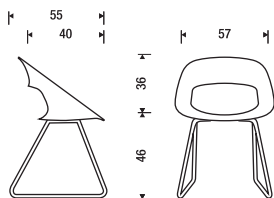

WHITE-VIT



GH106C-WHT

YELLOW-GUL



GH106C-YEL

BLUE-BLÅ



GH106C-BLU

TRANSPARENT



GH106C-TRN

GENOMLYSANDE ORANGE



GH106C-TRO

LED

Shell in polycarbonate
Stol i polykarbonat

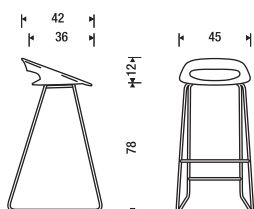

WHITE-VIT



LD106C-WHT

YELLOW-GUL



LD106C-YEL

BLUE-BLÅ



LD106C-BLU

TRANSPARENT



LD106C-TRN

Shell in polycarbonate and gaslift
Stol i polykarbonat och gaspelare

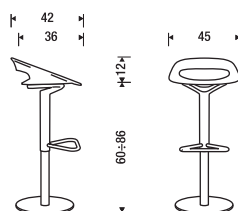

WHITE-VIT



LD156C-WHT

YELLOW-GUL



LD156C-YEL

BLUE-BLÅ



LD156C-BLU

TRANSPARENT



LD156C-TRN



GHOST







LED



LED

OBS! Tänk på att färgavikelser kan förekomma

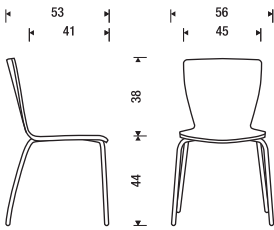
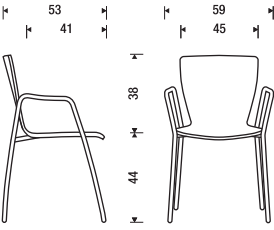
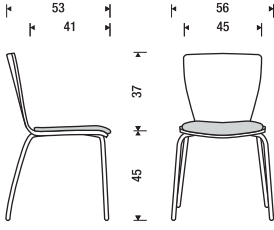
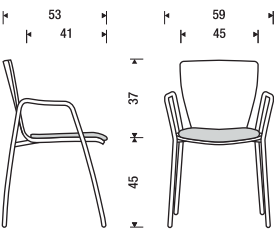
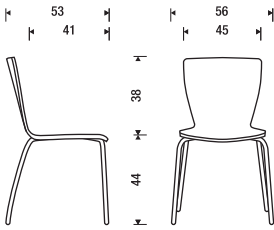
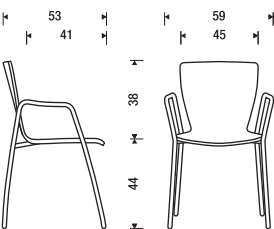
		10	30	50	70
					
Description / Benämning		Cod / Artikelnr			
 <p>53 41 56 45 38 44</p>	Beechwood chair, 4-leg frame without arms 4-bens stol i äkta bokträ utan armstöd				
	Chromed frame, beechwood structure natural varnished Klarlackat bokträ med kromade ben	FL101 C/TR			
	Chromed frame, beechwood structure cherry varnished Körsbärs betsad bokträ med kromade ben	FL101 C/CL			
	Chromed frame, beechwood structure white laquered Vitlackat bokträ med kromade ben	FL101 C/BN			
	Chromed frame, beechwood structure black laquered Svartlackat bokträ med kromade ben	FL101 C/NN			
 <p>53 41 59 45 38 44</p>	Beechwood chair, 4-leg frame with arms 4-bens stol i äkta bokträ med armstöd i krom				
	Chromed frame, beechwood structure natural varnished Klarlackat bokträ med kromade ben	FL201 C/TR			
	Chromed frame, beechwood structure cherry varnished Körsbärs betsad bokträ med kromade ben	FL201 C/CL			
	Chromed frame, beechwood structure white laquered Vitlackat bokträ med kromade ben	FL201 C/BN			
 <p>53 41 56 45 37 45</p>	Beechwood chair with padded seat, 4-leg frame 4-bens stol i äkta bokträ med klädd sits				
	Chromed frame, beechwood structure natural varnished Klarlackat bokträ med kromade ben	FL102 C/TR			
	Chromed frame, beechwood structure cherry varnished Körsbärs betsad bokträ med kromade ben	FL102 C/CL			
	Chromed frame, beechwood structure white laquered Vitlackat bokträ med kromade ben	FL102 C/BN			
 <p>53 41 59 45 37 45</p>	Chair with padded seat, 4-leg frame and arms in chrome 4-bens stol i äkta bokträ med klädd sits och armstöd i krom				
	Chromed frame, beechwood structure natural varnished Klarlackat bokträ med kromade ben	FL202 C/TR			
	Chromed frame, beechwood structure cherry varnished Körsbärs betsad bokträ med kromade ben	FL202 C/CL			
	Chromed frame, beechwood structure white laquered Vitlackat bokträ med kromade ben	FL202 C/BN			
 <p>53 41 56 45 38 44</p>	Upholstered chair, 4-leg frame in chrome Klädd stol med fyra ben i krom				
	Upholstered chair with frame in chrome Klädd stol med ben i krom	FL111 C/T			
 <p>53 41 59 45 38 44</p>	Upholstered chair, 4-leg frame and arms in chrome Klädd stol med fyra ben och armstöd i krom				
	Upholstered chair with frame and arms in chrome Klädd stol med ben och armstöd i krom	FL211 C/T			

Fabric / Klädsel

10	30	50	70

Description / Benämning

Cod / Artikelnr

Upholstered 2-3-4 seater with frame in chrome
Klädda 2-3-4 sits bänkar med underrede i krom

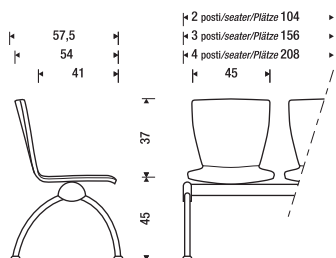

Upholstered 2 seats with chromed legs
Klädd 2 sits bänk med kromade ben

FL511 C/T-2P

Upholstered 3 seats with chromed legs
Klädd 3 sits bänk med kromade ben

FL511 C/T-3P

Upholstered 4 seats with chromed legs
Klädd 4 sits bänk med kromade ben

FL511 C/T-4P

Beechwood benches with padded seat panel
and chromed legs
Bänkar i bokträ med klädd sits och kromade ben

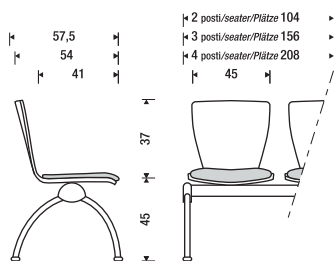

2 seats with beechwood structure natural varnished
2 sits i klarlackat bokträ med klädd sits, ben i krom

FL502 C/TR-2P

3 seats with beechwood structure natural varnished
3 sits i klarlackat bokträ med klädd sits, ben i krom

FL502 C/TR-3P

4 seats with beechwood structure natural varnished
4 sits i klarlackat bokträ med klädd sits, ben i krom

FL502 C/TR-4P

2 seats with beechwood structure cherry varnished
2 sits i körsbärsbetsat bokträ med klädd sits, ben i krom

FL502 C/CL-2P

3 seats with beechwood structure cherry varnished
3 sits i körsbärsbetsat bokträ med klädd sits, ben i krom

FL502 C/CL-3P

4 seats with beechwood structure cherry varnished
4 sits i körsbärsbetsat bokträ med klädd sits, ben i krom

FL502 C/CL-4P

White laquered seat/back, addon (price per piece)
Tillägg för Vitlackad sits/rygg (pris per st.)

T-BN1

Black laquered seat/back, addon (price per seat)
Tillägg för Svartlackad sits/rygg (pris per sits)

T-NN1

Armrest to benches (per pair)
Armstöd till bänkar (per par)

0513C



Black table dimensions 40x50x2,5 cm, accessories included
Amount to be added to two, three and four seater benches
Svart bord med mått 40x50x2,5 cm, tillbehör ingår
Kostnad att lägga till för 2-3-4 sits bänkar

PNC01

Replaces one seat with the table
Ersätter en sittplats med bordet

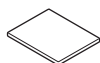

Trä



Klädd sits



Klädd med Armstöd



3 sitssoffa klädd sits

MELODE

Benches Bänkar

Fabric / Klädsel

10	30	50	70

Description / Benämning

Cod / Artikelnr

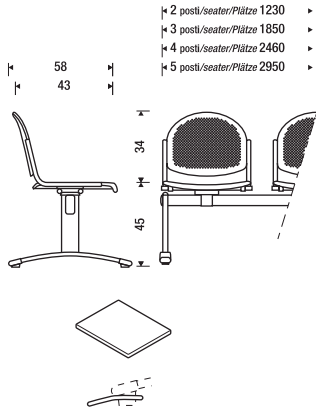

Bench with seat and backrest in perforated plate
Bänk med sits och rygg perforerad plåt

2 seats, grey structure
2 sits med grålackerad struktur

ML 151-2P

3 seats, grey structure
3 sits med grålackerad struktur

ML 151-3P

4 seats, grey structure
4 sits med grålackerad struktur

ML 151-4P

5 seats, grey structure
5 sits med grålackerad struktur

ML 151-5P

Black table dimensions 40x50x2,5 cm, accessories included
Amount to be added to two, three and four seater benches
Svart bord med mått 40x50x2,5 cm, tillbehör ingår
Kostnad att lägga till för 2-3-4 sits bänkar

TE12

Replaces one seat with the table
Ersätter en sittplats med bordet

Pair of wallspacers
Väggdistanser (par)

ML08

DAISY

Multifunctional sofa Sittpuffar

Fabric / Klädsel

10	30	50	70

Description / Benämning

Cod / Artikelnr

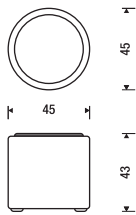

Round sofa 45 cm with glides
Rund sittpuff 45 cm med glidfötter

DY450

Round sofa 450 mm with glides
Rund sittpuff 450 mm med glidfötter

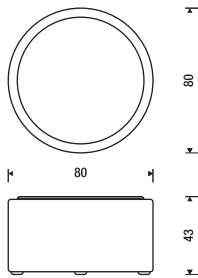

Round sofa 80 cm with glides
Rund sittpuff 80 cm med glidfötter

DY800

Round sofa 800 mm with glides
Rund sittpuff 800 mm med glidfötter

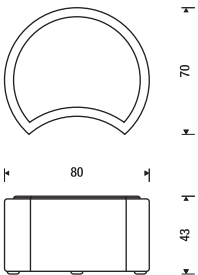

Convex/Round sofa 80 cm with glides
Convex / Rund sittpuff 80 cm med glidfötter

DY800 C

Convex sofa 800 mm with glides
Convex sittpuff 800 mm med glidfötter



Daisy



Daisy



Daisy



Melode

CHAIRS

Exclusive chairs Exklusiva Fåtöljer

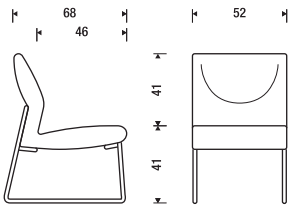
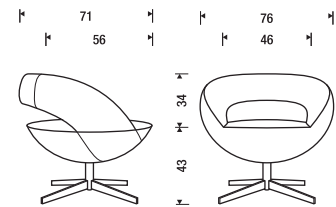
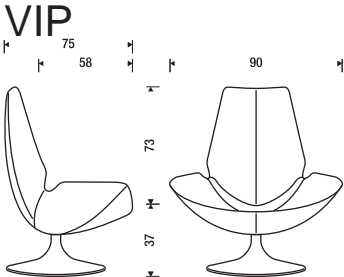
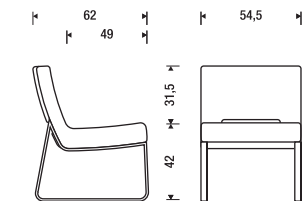
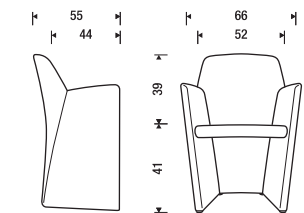
		Fabric / Klädsel			
		10	30	50	70
Description / Benämning		Cod / Artikelnr			
LYRA Seating system with chromed frame, without arms Enkelsoffa med kromunderrede utan armstöd Single Sofa, can be combined Singel soffa, kopplingsbar					
		LY101 C			
BARRY Elegant Armchair on 4-leg base in chrome Elegant fåtölj med 4-bens fot i krom Armchair with 4-leg base in chrome Fåtölj med armstöd med 4-bens fot i krom		BR101 C			
					
VIP Elegant armchair with conical shaped base in chrome Elegant fåtölj med armstöd och koniskt kromat underede Armchair with chromed conical shaped base, fixed Fåtölj med armstöd och koniskt kromat underede, fast		VP101 C			
					
MUSA Elegant Chair and 2 seater with chromed base, without arms Elegant fåtölj och 2 sits soffa med underrede i krom Chair with base in chrome Fåtölj med underrede i krom 2 seater with base in chrome 2 sits soffa med underrede i krom		CH101 C			
		CH101 C-2P			
STAGE Chair with foldable seat Fåtölj med fällbar sits Chair with foldable seat on glides Fåtölj med fällbar sits och glidfötter Addon for fold-away nylon writing tablet Tillägg för upp/ned fällbar skrivplatta i plast		SG97			
		SG05 T			



Lyra



Barry



Vip



Musa



Stage

		Fabric / Klädsel			
		10	30	50	70
	Description / Benämning				
	Cod / Artikelnr	-----			
	<p>Single sofa with backrest, legs in chrome Enkel soffa med rygg, ben i krom</p> <p>Seat and backrest, length 60 cm Sits och rygg, 60 cm lång</p>				
	<p>Single sofa with backrest, legs in chrome Enkel soffa med rygg, ben i krom</p> <p>Seat 80 cm and backrest 60 cm in length Sits 80 cm och rygg 60 cm i längd</p>				
	<p>Single sofa with backrest, legs in chrome Enkel soffa med rygg, ben i krom</p> <p>Seat and backrest, length 120 cm Sits och rygg, 120 cm lång</p>				
	<p>Single sofa with backrest, legs in chrome Enkel soffa med rygg, ben i krom</p> <p>Seat 140 cm and backrest 120 cm in length Sits 140 cm och rygg 120 cm i längd</p>				
	<p>Single sofa, legs in chrome Enkel soffa, ben i krom</p> <p>Seat 60 cm in length Sits 60 cm i längd</p>				
	<p>Single sofa, legs in chrome Enkel soffa, ben i krom</p> <p>Seat 80 cm in length Sits 80 cm i längd</p>				

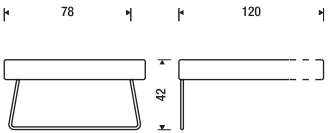
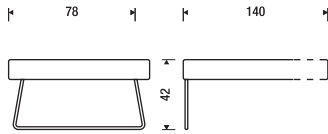
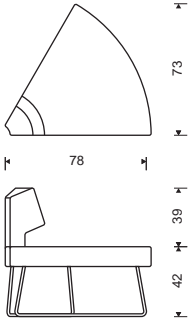
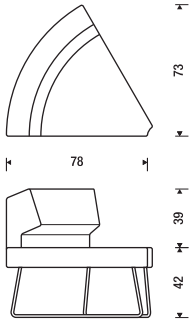
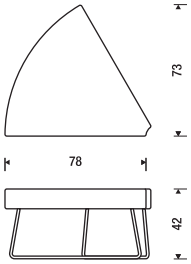
		Fabric / Klädsel			
		10	30	50	70
<p>Description / Benämning</p> <p>Cod / Artikelnr</p>					
<p>Single sofa, legs in chrome Enkel soffa, ben i krom</p>  <p>Seat 120 cm in length Sits 120 cm i längd</p>					
<p>Single sofa, legs in chrome Enkel soffa, ben i krom</p>  <p>Seat 140 cm in length Sits 140 cm i längd</p>					
<p>Curved sofa with convex backrest, legs in chrome Svängd soffa med convex rygg, ben i krom</p>  <p>60 degrees angle 60 graders vinkel</p>					
<p>Curved sofa with concave backrest, legs in chrome Svängd soffa med konkav rygg, ben i krom</p>  <p>60 degrees angle 60 graders vinkel</p>					
<p>Curved sofa, legs in chrome Svängd soffa, ben i krom</p>  <p>60 degrees angle 60 graders vinkel</p>					

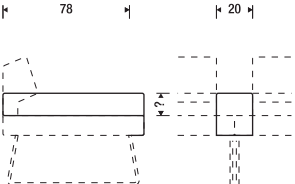
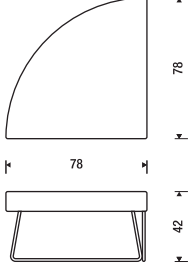
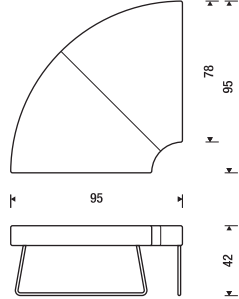
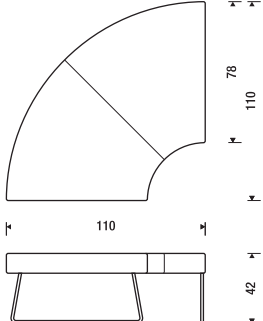
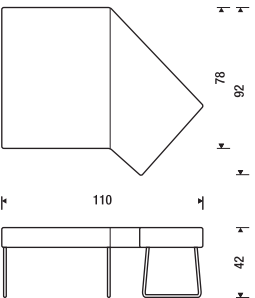
		Fabric / Klädsel			
		10	30	50	70
<p>Description / Benämning</p> <p>Cod / Artikelnr</p>					
<p>Armrest only when connecting sofas QK108 or QK114 Armstöd endast för koppling av QK108 eller QK114</p> 					
<p>Armrest Armstöd</p> <p>QK800</p>					
<p>Curved sofa, legs in chrome Svängd soffa, ben i krom</p> 					
<p>90 degrees angle 90 graders vinkel</p> <p>QK390</p>					
<p>Curved sofa with small internal curve, legs in chrome Svängd soffa med liten innersväng, ben i krom</p> 					
<p>90 degrees angle 90 graders vinkel</p> <p>QK391</p>					
<p>Curved sofa with large internal curve, legs in chrome Svängd soffa med med större innersväng, ben i krom</p> 					
<p>90 degrees angle 90 graders vinkel</p> <p>QK392</p>					
<p>Sofa end element, legs in chrome Soffavslutning, ben i krom</p> 					
<p>Leftangled end Vänstervinklat avslut</p> <p>QKDX400</p>					
<p>Rightangled end Högervinklat avslut</p> <p>QKDX400</p>					

QUICK

Multifunctional sofa serie
Soffserie byggbar



Övrigt

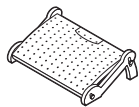

Footrest
Fotstöd

With adjustable inclination and height
Justerbar vinkling och höjd

PG

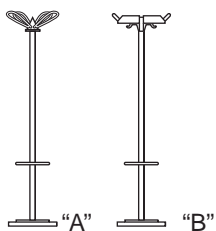

Coat rack
Klädhängare

Black epoxy painted "A"
Svartlackad

1001

Black epoxy painted "B"
Svartlackad

1021

Upholstery / Klädsel / Tyger



651  Rosso P-10

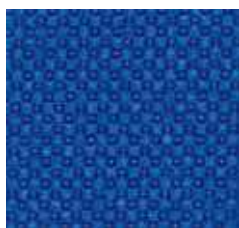

656  Blureale P-10



659  Verdechiaro P-10



657  Grigio P-10



654  Nero P-10



121 Rosso R-10



120 Viola R-10



126 BLU R-10

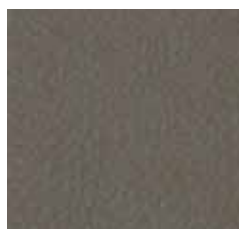

123 Tortora R-10

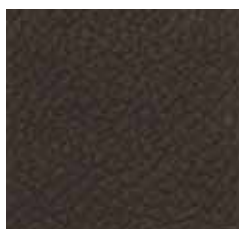

133 Testadimoro R-10

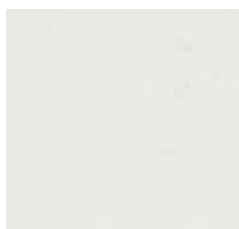

128 Bianco R-10

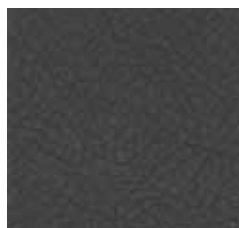

127 Grigiochiaro R-10



124 NERO R-10



160 Giallocra E-30



162 Azzurro E-30



156 Verdeggiada E-30



151 Camoscio E-30

P-RADIO



10

Composizione: 100% Poliestere FR
 Peso: Gr. 560/mtl
 Abrasione: UNI EN ISO 12947:2000 oltre 50.000 cicli Martindale
 Solidità luce/colore: UNI EN ISO 105-B02 Xenotest (6)
 Omologazione: I – Classe 1, EN - 1021 Part 1-2, UK – BS 7176 medium hazard, D – B1 DIN 4102, F – M1
 Le proprietà ignifughe sono intrinseche nella ? bra e non da trattamenti aggiuntivi

Composition: 100% Polyester FR
 Weight: Gr. 560/lmt
 Abrasion: UNI EN ISO 12947:2000 more than 50.000 Martindale cycles
 Color/Light solidity: UNI EN ISO 105-B02 Xenotest (6)
 Approvals: I – Classe 1, EN - 1021 Part 1-2, UK – BS 7176 medium hazard, D – B1 DIN 4102, F – M1
 he ? ame-retardant properties are inherent to the ? bre and are not provided by additional treatments

R-BLOOM

10

Composizione: 15% Poliuretano – 85% PVC
 Peso: Gr. 770/mtl
 Abrasione: UNI EN ISO 12947:2000 oltre 50.000 cicli Martindale
 Solidità luce/colore: UNI EN ISO 105-B02 Xenotest (6)

Composition: 15% Polyurethan – 85% PVC
 Weight: Gr. 770/lmt
 Abrasion: UNI EN ISO 12947:2000 more than 50.000 Martindale cycles
 Color/Light solidity: UNI EN ISO 105 B02 Xenotest (6)

E-RENNATECH

30

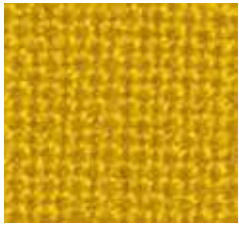

420 Giallolimone C-30

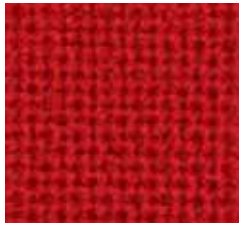

411 Rossovivo C-30

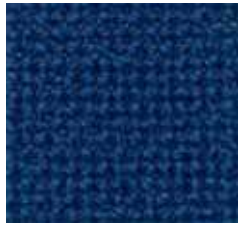

409 Blupavone C 30

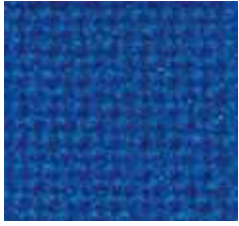

416 Blureale C 30



410 Verdebottiglia C 30



418 Marrone C 30

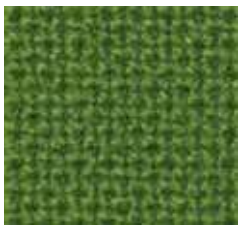

419 Verdementa C 30

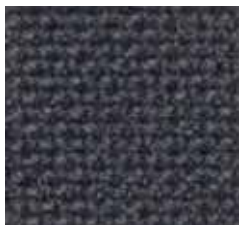

407 Grigio C-30



401 Nero C-30



725 Arancio D-30



720 Giallo D-30



721 Rosso D-30



738 Rubino D-30

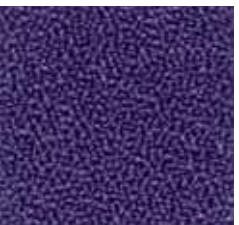

736 Viola D-30



732 Bluavio D-30



332 Celeste D 30



734 Bluscuro D-30



722 Azzurro D-30

C-TREVI



30

Composizione: 100% Poliestere FR (Trevira CS)

Peso: Gr. 630/mtl

Abrasione: UNI EN ISO 12947:2000 oltre 120.000 cicli Martindale

Solidità luce/colore: UNI EN ISO 105-B02 Xenotest (5)

Omologazione: I - Classe 1, EN - 1021 Part 1-2, F - M1, D - B1 DIN 4102, UK - BS 5852 Crib 5 OEKO TEX 072150.0 - IMO 688 (17), 563 (14), 653 (16)

Le proprietà ignifughe sono intrinseche nella ? bra e non da trattamenti aggiuntivi

Composition: 100% Polyester FR (Trevira CS)

Weight: Gr. 630/mtl

Abrasion: UNI EN ISO 12947:2000 more than 120.000 Martindale cycles

Color/Light solidity: UNI EN ISO 105-B02 Xenotest (5)

Approvals: I - Classe 1, EN - 1021 Part 1-2, F - M1, D - B1 DIN 4102, UK - BS 5852 Crib 5 OEKO TEX 072150.0 - IMO 688 (17), 563 (14), 653 (16)

The ? ame-retardant properties are inherent to the ? bra and are not provided by additional treatments

D-MIRAGE



30

Composizione: 100% Poliestere FR

Peso: Gr. 490/mtl

Abrasione: UNI EN ISO 12947:2000 oltre 100.000 cicli Martindale

Solidità luce/colore: UNI EN ISO 105-B02 Xenotest (5)

Omologazione: I - Classe 1, F - M1, D - B1 DIN 4102, BS7176 medium hazard EN - 1021 Part 1-2, A - B1 (OEnorm B3825), Q1 (Oenorm A3800 Teil 1) OEKO TEX 072150.0 - IMO 688 (17), 563 (14), 653 (16)

Composition: 100% Polyester FR

Weight: Gr. 490/mtl

Abrasion: UNI EN ISO 12947:2000 more than 100.000 Martindale cycles

Color/Light solidity: UNI EN ISO 105 B02 Xenotest (5)

Approvals: I - Classe 1, F - M1, D - B1 DIN 4102, GB - BS7176 medium hazard EN - 1021 Part 1-2, A - B1 (OEnorm B3825), Q1 (Oenorm A3800 Teil 1) OEKO TEX 072150.0 - IMO 688 (17), 563 (14), 653 (16)



333 Marrone D 30



727 Grigio D-30



724 Nero D-30



726 Blureale D-30



729 Verdementa D-30



739 Grigioscuro D-30

Upholstery / Klädsel / Tyger



266 Verdementa F-30



281  Rosso S-30



291  Rossoscuero S-30

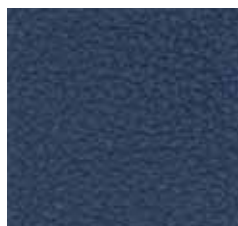

286  Bluscuro S-30

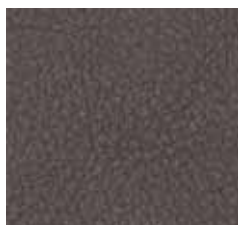

283  Tortora S-30

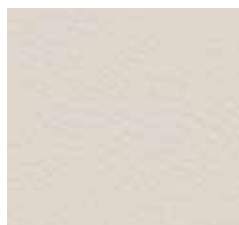

288  Magnolia S-30



114 Nero Z-30



340  Lilla T-30



349  Verdechiaro T-30

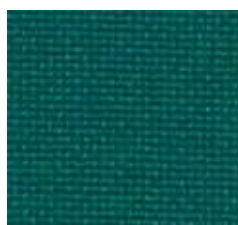

359  Verdescuro T-30



343  Tortora/arancio T-30



344  Tortora/nero T-30



345  Marrone T-30

F-PEGASO

30

Composizione: 64% Cotone - 36% Poliuretano (Traspirante)
Peso: Gr. 420/mtl
Abrasion: UNI EN ISO 12947:2000 oltre 50.000 cicli Martindale
Solidità luce/colore: UNI EN ISO 105-B02 Xenotest (6)

Composition: 64% Cotton - 36% Polyurethan (Perspirable)
Weight: Gr. 420/lmt
Abrasion: UNI EN ISO 12947:2000 more than 50.000 Martindale cycles
Color/Light solidity: UNI EN ISO 105 B02 Xenotest (6)

S-SKILL 

30

Composizione: 30% Cotone/Poliestere - 1% Poliuretano - 69% PVC
Peso: Gr. 730/mtl
Abrasion: UNI EN ISO 12947:2000 oltre 50.000 cicli Martindale
Solidità luce/colore: UNI EN ISO 105-B02 Xenotest (6)
Omologazione: I - Classe 1, UK - BS 5852-1:79, EN 1021 Part 2

Composition: 30% Cotton/Polyester - 1% Polyurethan - 69% PVC
Weight: Gr. 730/lmt
Abrasion: UNI EN ISO 12947:2000 more than 50.000 Martindale cycles
Color/Light solidity: UNI EN ISO 105 B02 Xenotest (6)
Approvals: I - Classe 1, UK - BS 5852-1:79, EN 1021 Part 2

Z-PLANET



30

Composizione: 12,5% Cotone - 87,5% PVC
Peso: Gr. 900/mtl
Omologazione: I - Classe 1, UK - BS 5852-1:79, EN 1021 Part 2

Composition: 12,5% Cotton - 87,5% PVC
Weight: Gr. 900/lmt
Approvals: I - Classe 1, UK - BS 5852-1:79, EN 1021 Part 2

T-KING NEW



30

Composizione: 100% Poliestere FR (Trevira CS)
Peso: Gr. 365/mtl
Abrasion: UNI EN ISO 12947:2000 oltre 60.000 cicli Martindale
Solidità luce/colore: UNI EN ISO 105-B02 Xenotest (5)
Omologazione: I - Classe 1, F - M1, D - B1 DIN 4102, UK - BS 5852 Crib 5, EN 1021 Part 1-2 OEKO TEX 072150.0 - IMO 688 (17), 563 (14), 653 (16)
Le proprietà ignifughe sono intrinseche nella ?bra e non da trattamenti aggiuntivi

Composition: 100% Polyester FR (Trevira CS)
Weight: Gr. 365/lmt
Abrasion: UNI EN ISO 12947:2000 more than 70.000 Martindale cycles
Color/Light solidity: UNI EN ISO 105-B02 Xenotest (5)
Approvals: I - Classe 1, F - M1, D - B1 DIN 4102, UK - BS 5852 Crib 5, EN 1021 Part 1-2 OEKO TEX 072150.0 - IMO 688 (17), 563 (14), 653 (16)
The ?ame-retardant properties are inherent to the ?bre and are not provided by additional treatments



565  Arancio M-50



551  Rossovivo M-50



559 Verdechiaro M-50

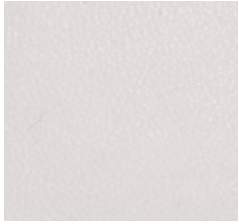

558  Bianco M-50



554  Nero M-50



801  Rosso G-50

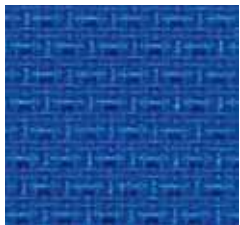

826  Blu reale G-50



822  Azzurro G-50

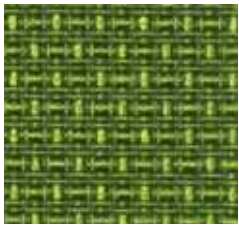

829 Verde G-50



805 Marrone G-50



823 Beige G-50

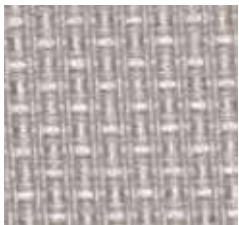

807  Grigio chiaro G-50



827  Grigio G-50



804  Nero G-50



523  Marrone L-50

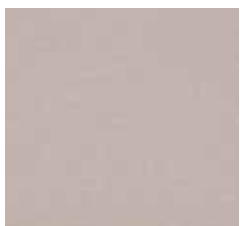

507  Grigio chiaro L-50

M-MOOD



50

Composizione: 25% Cotone - 3% Poliuretano - 72% PVC
Peso: Gr. 970/mtl
Abrasione: UNI EN ISO 5470-2/03 oltre 50.000 cicli Martindale
Solidità luce/colore: UNI EN ISO 105-B02 Xenotest (6)
Omologazione: I - Classe 1, UK - BS 5852 Crib 5, EN 1021 Part 2
Antimuffa e antiacaro con Vinyzene by Bio-Pruf

Composition: 25% Cotton - 3% Polyurethan - 72% PVC
Weight: Gr. 970/mt
Abrasion: UNI EN ISO 12947:2000 more than 50.000 Martindale cycles
Color/Light solidity: UNI EN ISO 105 B02 Xenotest (6)
Approvals: I - Classe 1, UK - BS 5852 Crib 5, EN 1021 Part 2
Antimicrobial and anti-mould agent Vinyzene by Bio-Pruf

G-TRAVEL



50

Composizione: 100% Poliestere FR (Trevira CS)
Peso: Gr. 630/mtl
Abrasione: UNI EN ISO 12947:2000 oltre 110.000 cicli Martindale
Solidità luce/colore: UNI EN ISO 105-B02 Xenotest (6)
Omologazione: I - Classe 1, F - M1, D - B1 DIN 4102, UK - BS 7176 medium hazard, EN 1021 Part 1-2
Le proprietà ignifughe sono intrinseche nella ? bra e non da trattamenti aggiuntivi

Composition: 100% Polyester FR (Trevira CS)
Weight: Gr. 630/mt
Abrasion: UNI EN ISO 12947:2000 more than 110.000 Martindale cycles
Color/Light solidity: UNI EN ISO 105-B02 Xenotest (6)
Approvals: I - Classe 1, F - M1, D - B1 DIN 4102, UK - BS 7176 medium hazard, EN 1021 Part 1-2
The ? ame-retardant properties are inherent to the ? bre and are not provided by additional treatments

L-SILK



50

Composizione: 25% Cotone - 3% Poliuretano - 72% PVC
Peso: Gr. 970/mtl
Abrasione: UNI EN ISO 5470-2/03 oltre 50.000 cicli Martindale
Solidità luce/colore: UNI EN ISO 105-B02 Xenotest (6)
Omologazione: I - Classe 1, UK - BS 5852 Crib 5, EN 1021 Part 2
Antimuffa e antiacaro con Vinyzene by Bio-Pruf

Composition: 25% Cotton - 3% Polyurethan - 72% PVC
Weight: Gr. 970/mt
Abrasion: UNI EN ISO 12947:2000 more than 50.000 Martindale cycles
Color/Light solidity: UNI EN ISO 105 B02 Xenotest (6)
Approvals: I - Classe 1, UK - BS 5852 Crib 5, EN 1021 Part 2
Antimicrobial and anti-mould agent Vinyzene by Bio-Pruf

Upholstery / Klädsel / Tyger



901  Rosso H-50

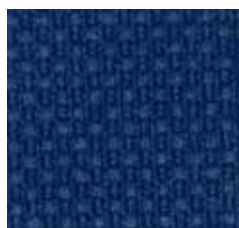

909  Bluscuro H-50



906  Blureale H-50

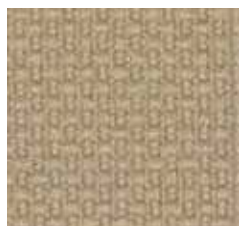

923 Sabbia H-50

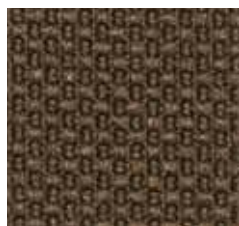

905 Marrone H-50



907  Grigio H-50

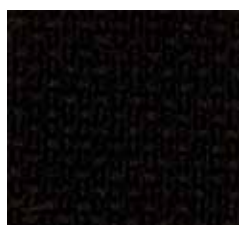

904  Nero H-50

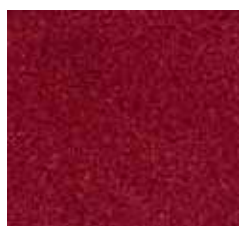

951  Rossoscuro V-50



956  Blu V-50



959  Verdechiaro V-50



953  Beige V-50



963  Marrone V-50



954  Nero V-50

H-QUADRO



50

Composizione: 100% Poliestere FR (Trevira CS)

Peso: Gr. 630/mtl

Abrasione: UNI EN ISO 12947:2000 oltre 70.000 cicli Martindale

Solidità luce/colore: UNI EN ISO 105-B02 Xenotest (5)

Omologazione: I - Classe 1, F - M1, D - B1 DIN 4102, UK - BS 5852 Crib 5, EN 1021 Part 1-2 OEKO TEX 072150.0 - IMO 688 (17), 563 (14), 653 (16)

Le proprietà ignifughe sono intrinseche nella ? bra e non da trattamenti aggiuntivi

Composition: 100% Polyester FR (Trevira CS)

Weight: Gr. 630/lmt

Abrasion: UNI EN ISO 12947:2000 more than 70.000 Martindale cycles

Color/Light solidity: UNI EN ISO 105-B02 Xenotest (5)

Approvals: I - Classe 1, F - M1, D - B1 DIN 4102, UK - BS 5852 Crib 5, EN 1021 Part 1-2 OEKO TEX 072150.0 - IMO 688 (17), 563 (14), 653 (16)

The ? ame-retardant properties are inherent to the ? bre and are not provided by additional treatments

V-ALKEMIA PLUS 50

Composizione: 25% Cotone - 3% Poliuretano - 72% PVC

Peso: Gr. 970/mtl

Abrasione: UNI EN ISO 5470-2/03 oltre 50.000 cicli Martindale

Solidità luce/colore: UNI EN ISO 105-B02 Xenotest (6)

Omologazione: I - Classe 1, UK - BS 5852 Crib 5, EN 1021 Part 2 Antimuffa e antiacaro con Vinyzene by Bio-Pruf

Composition: 25% Cotton - 3% Polyurethan - 72% PVC

Weight: Gr. 970/lmt

Abrasion: UNI EN ISO 12947:2000 more than 50.000 Martindale cycles

Color/Light solidity: UNI EN ISO 105 B02 Xenotest (6)

Approvals: I - Classe 1, UK - BS 5852 Crib 5, EN 1021 Part 2 Antimicrobial and anti-mould agent Vinyzene by Bio-Pruf



209 Gialloocra N-70



221 Rossosivo N-70



207 Blunotte N-70



222 Azzurro N-70

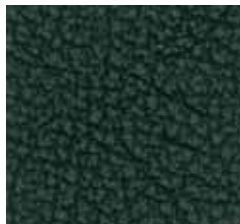

206 verdebottiglia N-70



225 Testadimoro N-70



223 Beige N-70



208 Avorio N-70

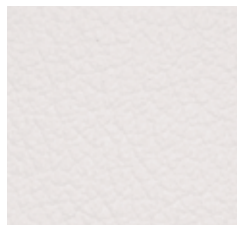

224 Bianco N-70

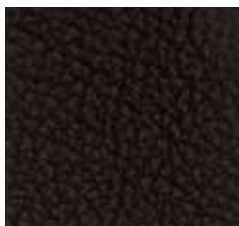

204 Nero N-70

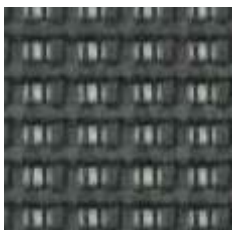

Grigio R07



Blu R06



Verde R09



Arancio R05



Rosso R01

N-PELLE-LEATHER 70



Pelle bovina naturale prima scelta.

Spessore: 1 mm

Rifinitura poliuretana

Buona resistenza a luce e sfregamento

Manutenzione

Pulizia: con aspirapolvere

Lavaggio: con spugna umida, asciugando immediatamente.

La vera pelle può presentare delle imperfezioni o delle lievi variazioni di tonalità che, visto la naturalità del prodotto, non possono essere considerati un difetto.

First choice natural bovine leather

Thickness: 1 mm

Polyurethane finishing

Good resistance to light and friction

Maintenance

Cleaning: vacuum cleaner

Washing: wet towel or sponge, dry immediately

Real leather can present some imperfections and/or slight changes of the color shading. On account of the product genuineness, they cannot be considered defects of the product itself.

KELLY NET

The up-and-down adjustment of the backrest and the lumbar support guarantees a natural support and allows for a direct discharge of the body weight to the ground.

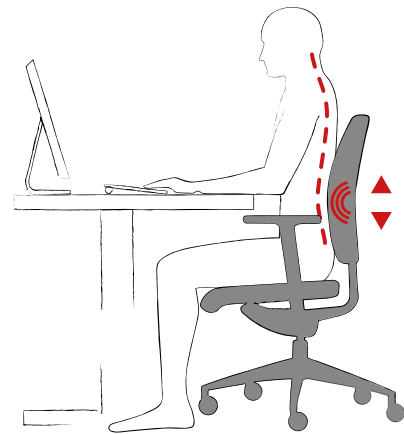

The seat and the armrest adjustment systems guarantee a comfortable posture, adapting to the body conformation of any end user.

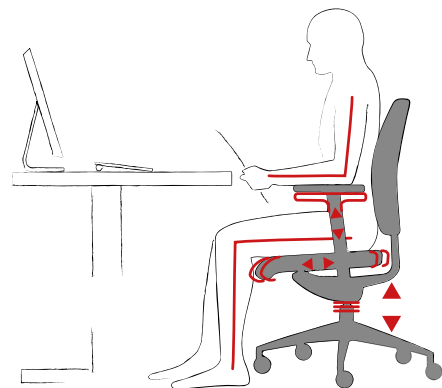

Tilting of the backrest synchronized with the movement of the seat, helps for spontaneous movement and allows for easy change of positions.



Holmbergs**bordet**
INTERIOR

Holmberg**s**bordet Interior, Borgargatan 21, 870 52 Nyland
Tel. 0612-224 35, Fax 0612-222 12
[info@holmberg**s**bordet.se](mailto:info@holmbergsbordet.se), [www.holmberg**s**bordet.se](http://www.holmbergsbordet.se)