

Plan View
scale 1 : 40 mm

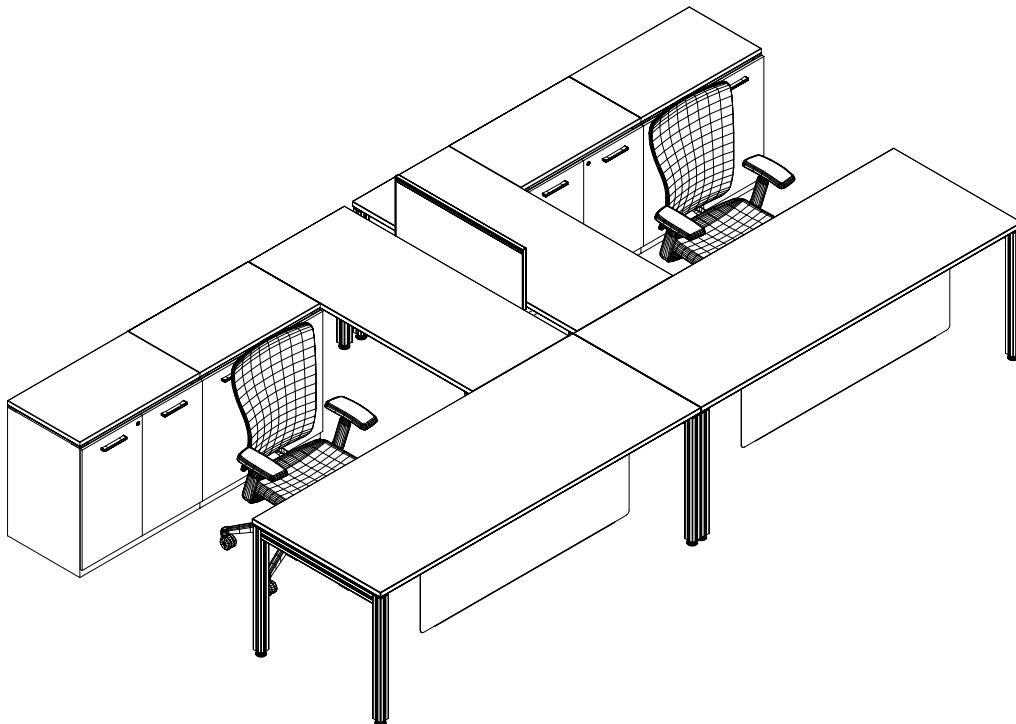

3D Isometric
not to scale