

Plan View
scale 1 : 10 mm

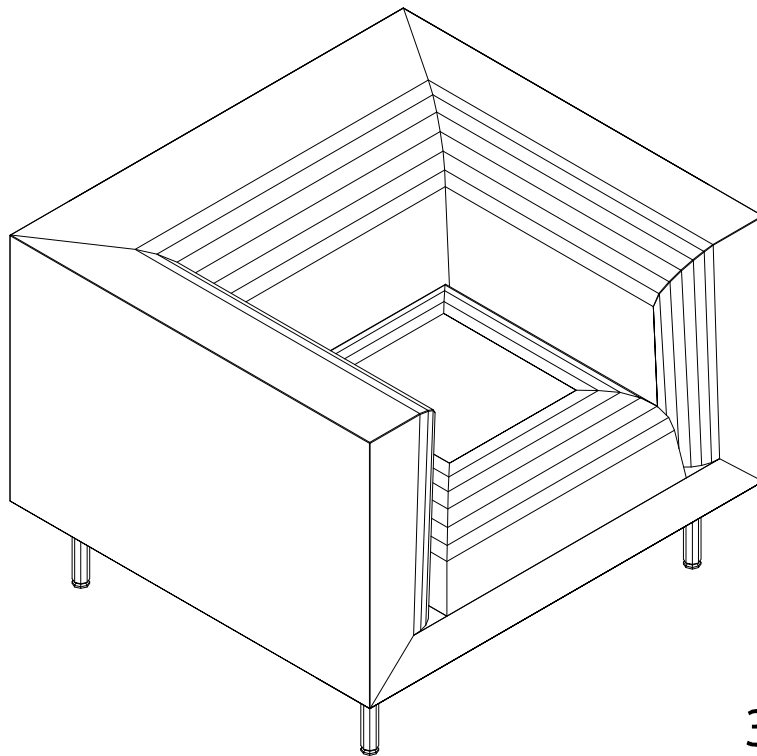

3D Isometric
not to scale