

PANEL FINISHES:

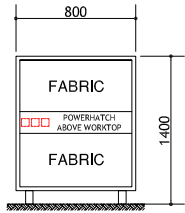

(A) FRONT

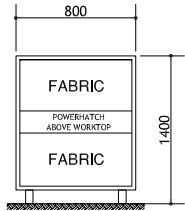

(A) REAR

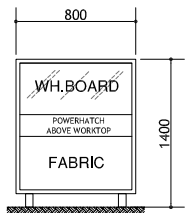

(B) BOTH SIDES

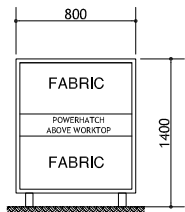

(C) BOTH SIDES

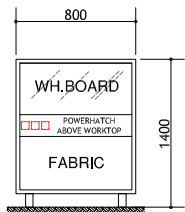

(D) FRONT

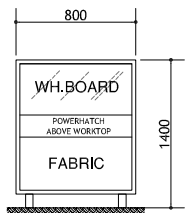

(D) REAR

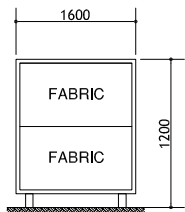

(E) BOTH SIDES

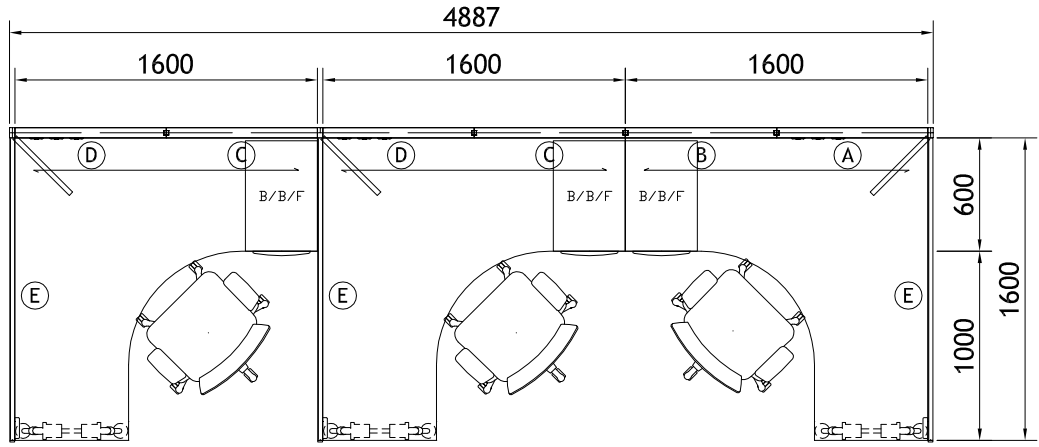

Plan View
scale 1 : 40 mm

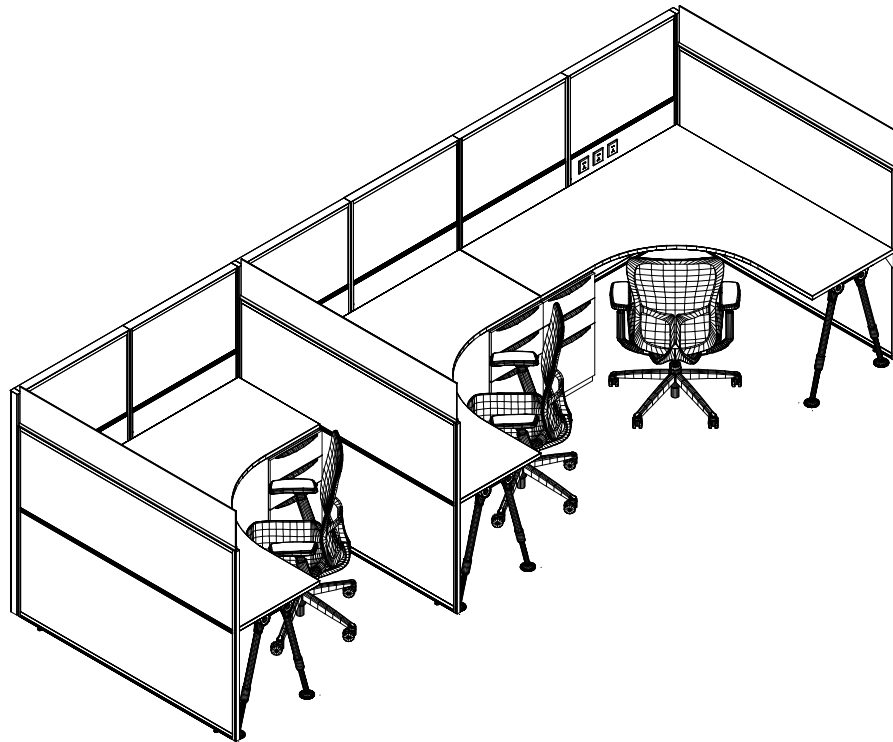

3D Isometric
not to scale