

**Plan View**  
scale 1 : 40 mm

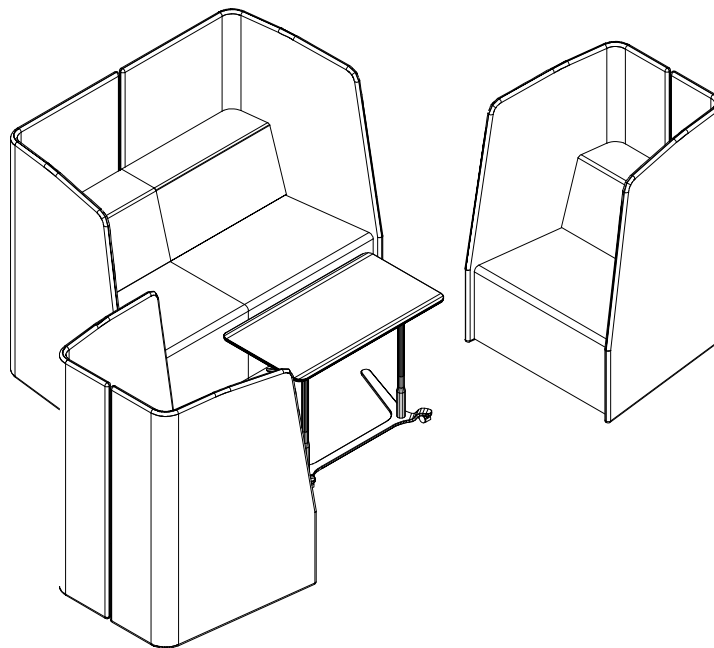

**3D Isometric**  
not to scale