

PANEL FINISHES:

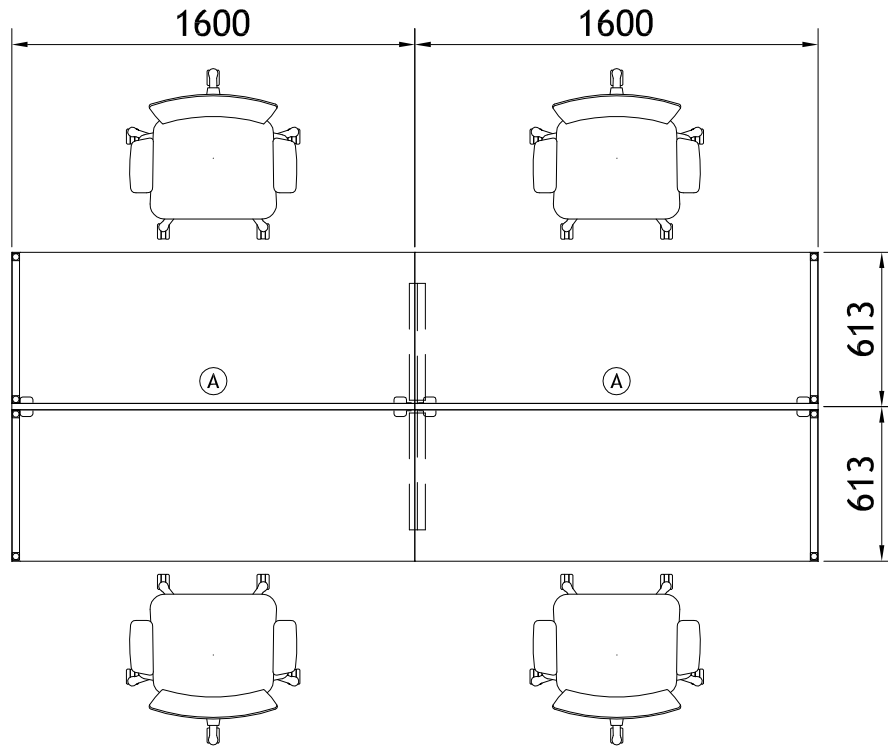

Plan View
scale 1 : 30 mm

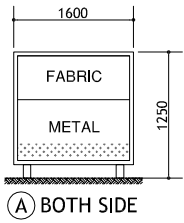
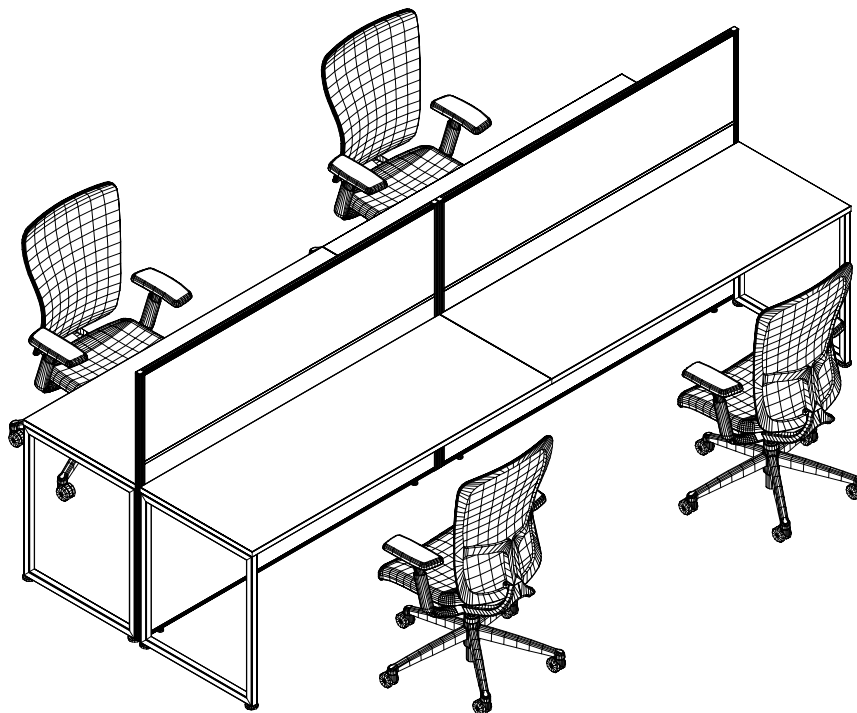

3D Isometric
not to scale